

INSTALLATION:

4

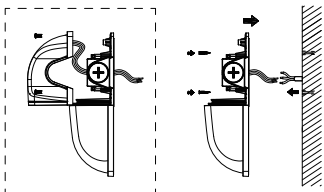

5

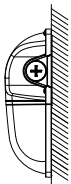

6

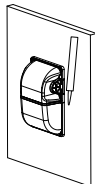

Apply weatherproof silicone sealant between the wall and fixture housing to ensure a weatherproof installation.

Selectable CCT and wattage function installation:

1

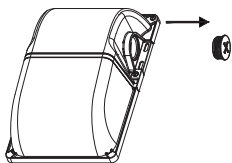

2

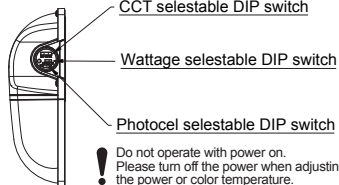

! Do not operate with power on. Please turn off the power when adjusting the power or color temperature.

WARRANTY:

5-YEAR WARRANTY

if this product fail to perform satisfactorily due to defect or poor workmanship within five years from the date of purchase, return it to the place of purchase and it will be replaced, free of charge. Incidental or consequential damages are excluded from the warranty.

LED Mini Wall Pack

Installation Instructions

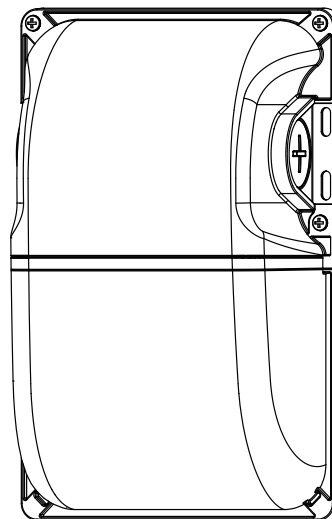

30W

DIMENSIONAL DRAWING:

Unit: mm/inch

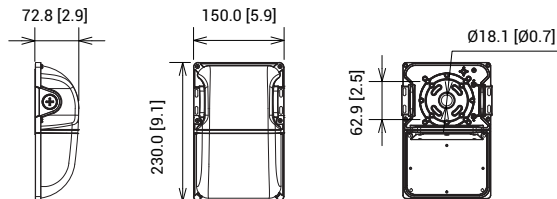

SAFETY INSTRUCTION:

- This fixture must be wired in accordance with the international electrical code and applicable local codes and ordinances.
- Proper grounding is required to insure personal safety. Carefully observe the correct grounding procedure under installation section.
- Make sure power off before installing or maintaining fixture.
- Check that voltage is compatible with fixture driver, use approved connectors for all electrical connections.

IMPORTANT: READ CAREFULLY BEFORE INSTALLING FIXTURE. RETAIN FOR FUTURE REFERENCE.

CLEANING:

1. Before touching fixture, make sure the fixture is cooling.
2. Do not clean or maintain while fixture is energized.
3. Clean lens & fixture with non-abrasive glass cleaning solution.
4. Do not open fixture to clean and touch LED chips.

MAINTENANCE CAUTION:

1. Review the diagrams before beginning, and make sure the fixture is grounded properly.
2. Turn the power off and wait for fixture cooling to operate.
3. This fixture has to be installed or maintenance in accordance with the application code by a professional person who familiar with the construction and operation of the product and the hazards involved.

WIRING INSTRUCTION:

WARNING: TURN OFF POWER BEFORE CONNECTING WIRES.

Black wire connect to L White wire connect to N, Green wire connect to GROUND.
For 0-10V dimming, the wiring direction as below:

1. Turn off the power.
 2. Connect the BLACK wire with the LINE.
 3. Connect the WHITE wire with the COMMON
 4. Connect the GREEN wire with the GROUND.
- Caution: DO NOT connect the PINK(-)DIM V- wire with GROUND
5. Connect the PURPLE wire with the (V+) DIM.
 6. Connect the PINK wire with the (V-) DIM.

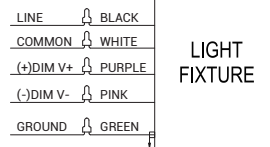

INSTALLATION:

Tools: Phillips head screw driver and electrical wiring tools.

1

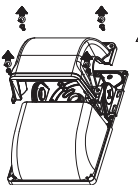

2



3

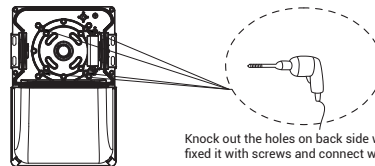

Note: Knock out the holes on back side with tool, and then fixed it with screws and connect with cable.

Note: Drill holes in rear housing and mount housing to surface, sealant should be used around mounting points to avoid water intrusion.