

# LED FRAME LIGHT

## J-F2F4®

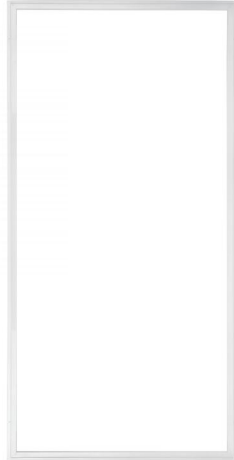
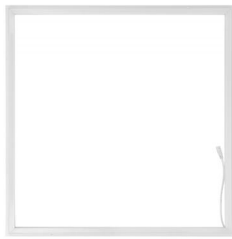
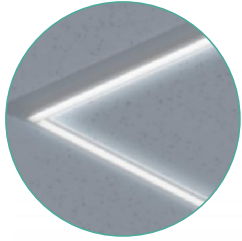

### FEATURES AND SPECIFICATIONS

#### Construction

- Frame comes in 2x2 and 2x4 options, offering a sleek, modern look with top-notch functionality
- Wattage and CCT selectable reduce your stock SKU
- Cutting-edge optical tech, it matches the lighting specs of traditional LED panels

#### Electrical

- Input voltage: 120-277V
- Operating frequency: 50/60Hz
- Power factor: >0.95
- Ambient temperature range: -20°C ~+45°C
- Color Temp: 3000/3500/4000/5000/6500K
- Dimmable: 0-10V dimming
- THD: <10%
- IP Rating: IP40
- CRI: >80
- Beam angle: 120°

#### Applications

- Offices, retail, schools, restaurants, residential

#### Installation

- Fixture is suitable for recessed mounting with T-bar
- Suspended installation

#### Listing

- ETL listed, suitable for damp location.
- DesignLights Consortium® (DLC) Premium

#### Warranty

- 5-year limited warranty

Specs at a Glance	* Nominal Wattage (Switchable)	
Configuration	F2-K40-3065	F4-K60-3065
CCT (K)	3000K-3500K-4000K-5000K-6500K(Switchable)	
Wattage (W)*	20/30/40W wattage adjustable	40/50/60W wattage adjustable
Lumens (lm)	20W=2500lumens 30W=3750lumens 40W=5000lumens	40W=5000lumens 50W=6250lumens 60W=7500lumens
Effcacy (LPW)	Up to 125lm/w	
CRI	>80	
Input Voltage	120-277V	
Operating Temp	-20°C ~45°C	
Certifications	ETL&DLC Premium	
Warranty	5-year limited warranty	

# LED FRAME LIGHT

## Ordering information

Model	Description
F2-K40-3065	2' x 2' LED frame Light, Power Switchable 20W/30W/40W, Color Switchable 3000K/3500K/4000K/5000K/6500K, 120-277VAC
F4-K60-3065	2' x 4' LED frame Light, Power Switchable 40W/50W/60W, Color Switchable 3000K/3500K/4000K/5000K/6500K, 120-277VAC

## Detail

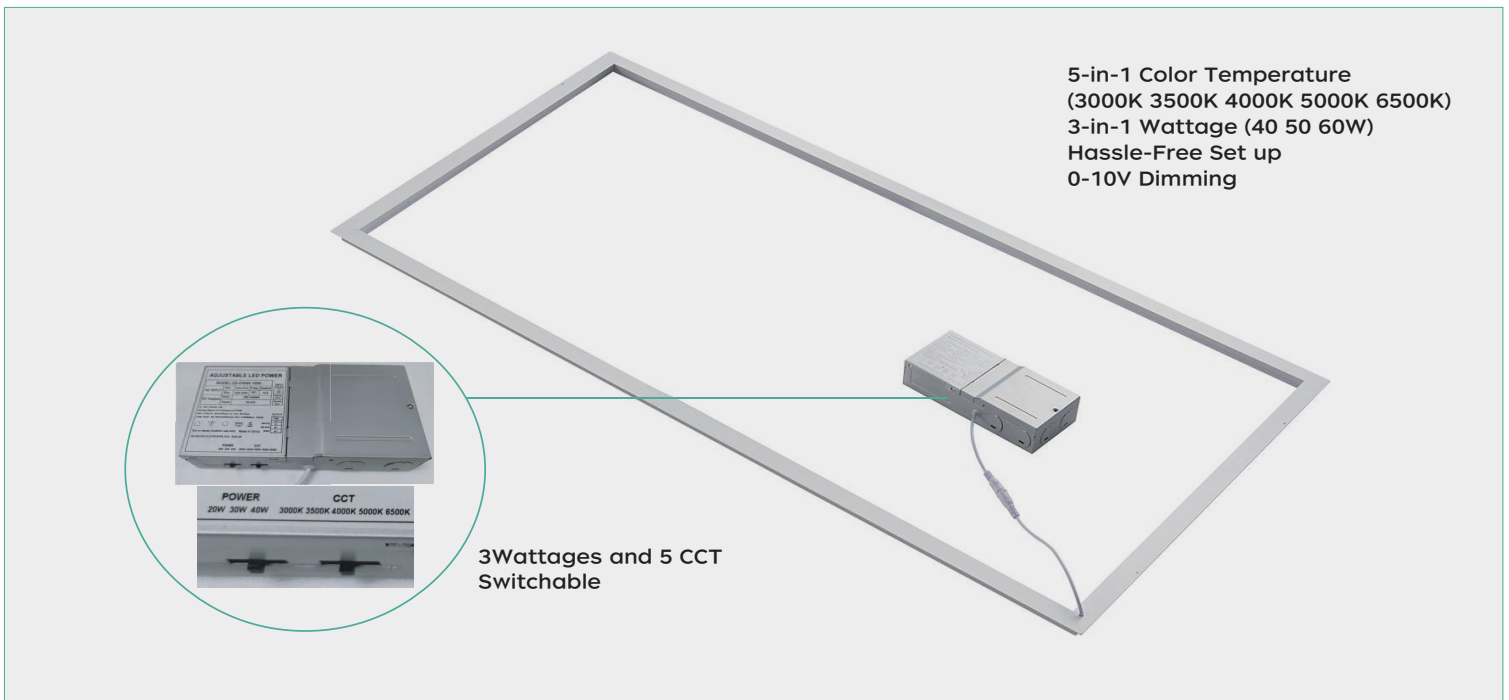

## Dimensions

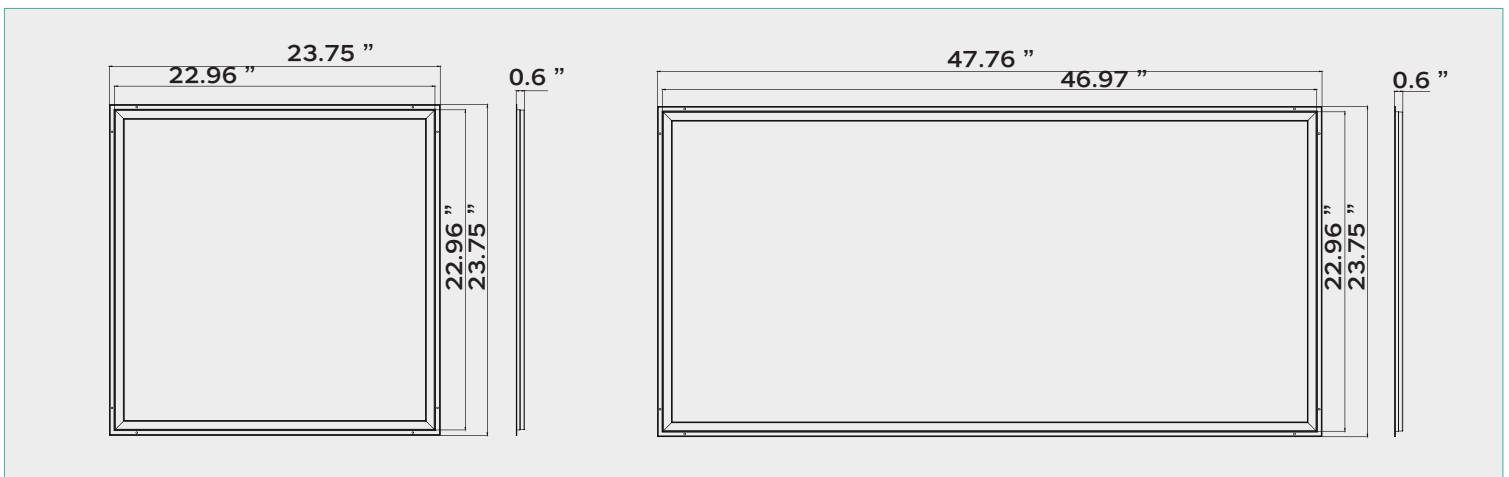

# LED FRAME LIGHT

## Installation Instruction

### Recessed Mounting

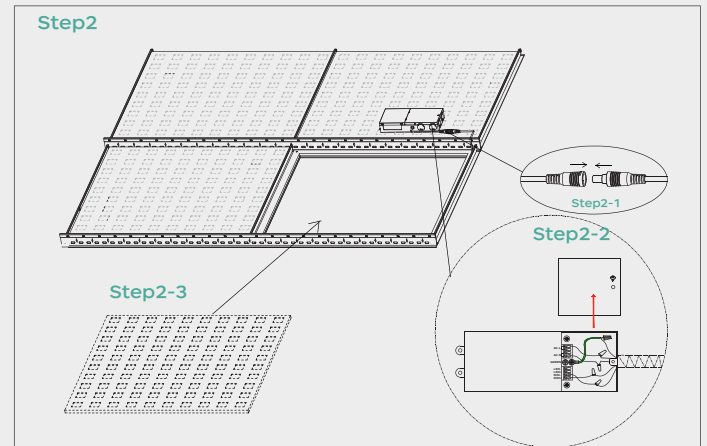
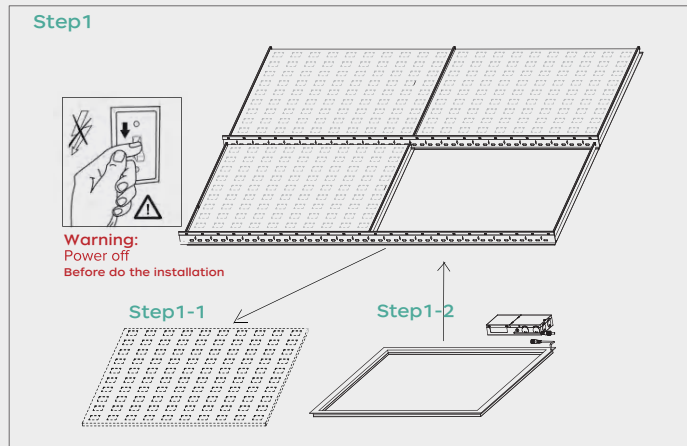

### Suspended mounting

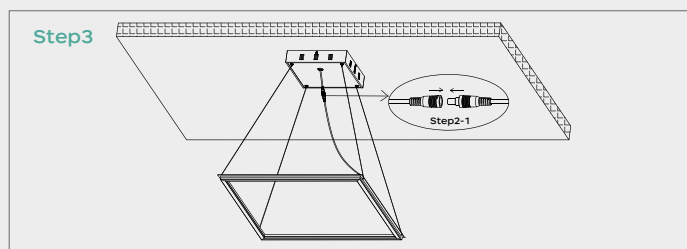
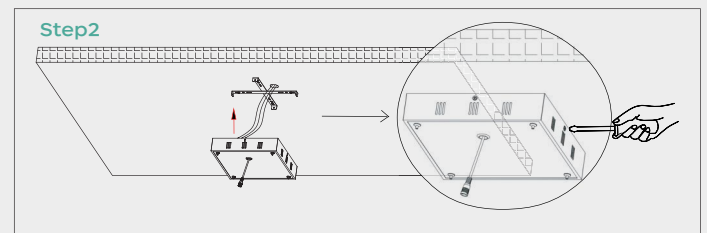
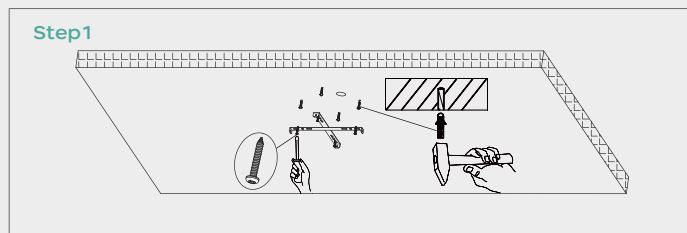

**Step 1:** Fix the bracket of the canopy to the ceiling;

**Step 2:** Put the driver into the canopy and connect the AC input wire, then dimming wire; align the canopy horizontally upwards with the 4 holes of the bracket and screw tightly.

**Step 3:** Fasten the 4 lifting ropes to the 4 holes at the light fixture and then to the 4 holes at the canopy, latch on; then plug in the male-female connector of the driver and light fixture, installation complete!

**Warning:**

Make sure all the power is off before installation. All the installations are required to be done by professionals.

# LED FRAME LIGHT

## Wiring Diagram

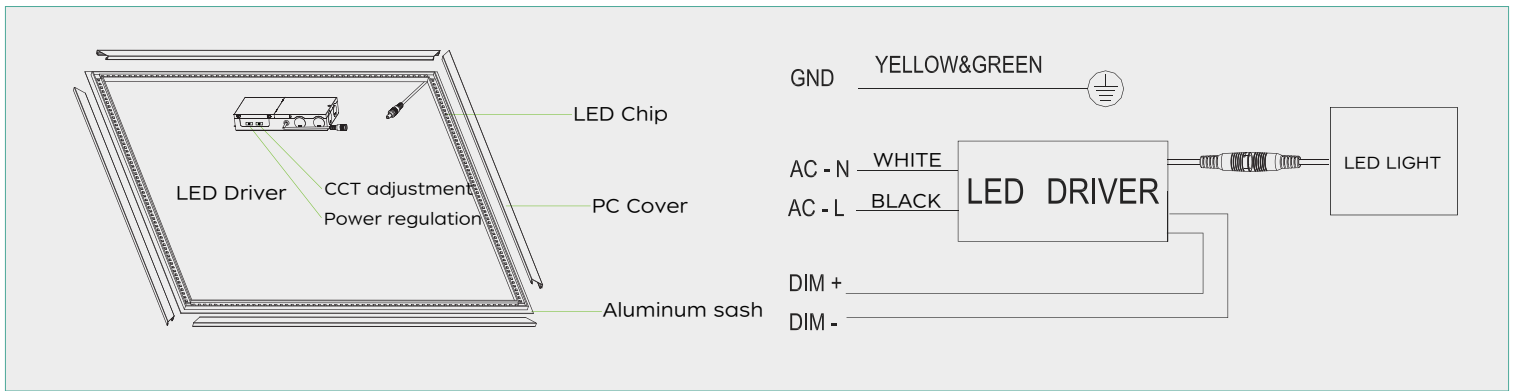

## Packing Information

Size/ft	L /inch	W /inch	H /inch	QTY/ctn	G.W./lbs
2x2'	27.9	25.5	9	6	15.8
2x4'	51	25.5	9	6	21